

GPS Receiver System

SOKKIA

RADIANTM IS

Operations Manual

Part Number 750-1-0069 Rev 1

Copyright Notice

© 2000 POINT, Inc. All rights reserved.

No part of this publication or the equipment described in it may be reproduced, translated, stored in a retrieval system, or transmitted in any form or by any means, electronic, mechanical photocopying, recording, or otherwise, without prior written permission of Point, Inc. Your rights with regard to this publication and the equipment are subject to the restrictions and limitations imposed by the copyright laws of the United States of America ("U.S.A.") and/or the jurisdiction in which you are located.

Trademark Notice

Sokkia is a trademark of Sokkia Co. Ltd. Spectrum, SDR and Electronic Field Book are registered trademarks of POINT, Inc. Radian is a trademark of POINT, Inc. All other product and brand names are trademarks or registered trademarks of their respective holders.

FCC Notice

The equipment described in this manual has been tested pursuant to Part 15 of the FCC Rules and found to comply with the limits for a Class A digital device for use in commercial business, and industrial environments. Operation is subject to the following two conditions: (1) this device may not cause harmful interference, and (2) this device must accept any interference received, including interference that may cause undesired operation. These limits are designed to provide reasonable protection against harmful interference when the equipment is operated in a commercial environment. The equipment generates, uses, and can radiate radio frequency energy and, if not installed and used in accordance with the instruction manual, may cause harmful interference to radio and television reception. Operation of this equipment in a residential area is likely to cause harmful interference in which case the user will be required to correct the interference at his own expense.

If this equipment does cause interference to radio or television reception, which can be determined by turning the equipment off and on, you can try to correct the interference by one or more of the following measures:

- Reorient the receiving antenna.
- Relocate the receiver relative to the equipment which it interferes.
- Power the equipment from a different AC receptacle so that this equipment and the interfered equipment are on different branch circuits. If necessary, contact our customer service department or an authorized representative for additional advice.

CE Notice

Warning: This is a Class A product. In domestic environments this product may cause radio interference in which case the user may be required to take adequate measures.

Printed on recycled paper.



Part# 750-1-0069 Rev 1

00-00015-12

Contents

Chapter 1	Introduction	1
1.1	What is the Radian™ IS?.....	1
1.2	Ports and Icons	2
1.3	Features	3
1.4	Where to Find Information.....	6
1.5	Obtaining Technical Assistance	6
1.6	Notes, Cautions, and Warnings	8
1.7	Radian IS Usage Cautions	9
Chapter 2	Setting-Up The Radian IS	10
2.1	Getting Started.....	10
2.1.1	Setting up at the office	10
2.1.2	Setting up in the field.....	11
Chapter 3	Radian IS Components	15
3.1	Enclosure Feature Overview	15
3.2	Access Door	17
3.2.1	Opening and closing the access door	18
3.2.2	Data card	18
3.2.3	Battery.....	20
3.3	Ports.....	22
3.3.1	Power port and power input.....	24
3.3.2	Communications ports and power output	24
3.4	Wireless Communications.....	25
3.5	GPS Antenna	25
3.6	Display Panel.....	26

Chapter 4	Using the Radian IS	28
4.1	Power Supply and Control.....	28
4.1.1	Turn system on.....	28
4.1.2	System inactivity.....	28
4.1.3	Scheduled session.....	29
4.1.4	Data logging interruption.....	29
4.1.5	Power source.....	29
4.1.6	Power consumption.....	30
4.1.7	Insufficient power.....	31
4.2	Display Panel Operations.....	31
4.2.1	Power button.....	31
4.2.2	Audible annunciator.....	33
4.2.3	Gauges.....	34
4.3	Internal Status Indicators.....	38
4.3.1	Data card indicator.....	39
4.3.2	Battery indicator.....	39
4.4	General Operations.....	39
4.5	Data Collection Fundamentals.....	42
4.5.1	Collecting data.....	42
4.5.2	Defining data to be collected.....	45
4.5.3	Data file naming.....	48
4.5.4	Data storage requirements.....	50
4.5.5	Resetting the receiver.....	50
Appendix A	Radian IS Specifications	51
Glossary		55
Index		63

Figures

1	Illustration of typical static setup	11
2	Illustration of typical base setup	12
3	Illustration of vehicle setup	13
4	Illustration of typical RTK rover setup	14
5	Ports and single access door	15
6	Mounting socket	16
7	Display panel and antenna	16
8	Access door open	17
9	Access door closed and open	18
10	Ports	23
11	Antenna	26
12	Panel display	27
13	Data card indicator	39
14	Battery indicator	39
15	Radian IS general operations	41

1.1 What is the Radian™ IS?

Welcome to the Radian IS Operations Manual. This manual will provide you with complete information about your Radian IS (integrated system) and its function.

The Sokkia Radian IS is a state-of-the-art, real-time kinematic, post-processing, dual-frequency, survey-grade GPS solution. The Radian IS is the next generation of Radian receiver!

One exciting characteristic of the new Radian IS is that it features a more powerful GPS engine, yet it uses very little power. As well, the new Radian IS integrates the receiver, antenna, data memory and batteries into one lightweight and rugged component. Integrating the components of the system means you will have fewer cables to connect.

Wireless data transmission is another exciting feature offered with the Radian IS. Transferring your data from the receiver to the data collector through a wireless communications port is a unique characteristic that eliminates troublesome cables found in conventional GPS surveying systems.

Surveyors can use the Radian IS for topographic stake-out and control surveys. As well, the innovative design of the Radian IS receiver will help reduce the man-power necessary because it eliminates the limitations of traditional survey methods such as requiring line of sight between points.

The Radian IS is used for RTK or post processing applications, and it uses proven PAC™ (Pulse Aperture Correlator) technology, combined with a powerful 32-bit microprocessor.

Excellent acquisition and re-acquisition times means this receiver will operate in environments where signal obstructions are present and frequent interruption of signals can be expected.

The Radian IS features a rugged, reliable design for use in adverse environments, and it will provide years of reliable operation.

Use the Radian IS handheld component (SDR[®] Level 5) and the Radian IS desktop software (Spectrum[®] Survey Suite) with the Radian IS receiver. When used together, you will have a complete solution that provides powerful state-of-the-art technology, and an intuitive, easy-to-use GPS system.

1.2 Ports and Icons



This icon is the symbol for communications and identifies the handheld communications port on the side of the Radian IS receiver. The communications port is also referred to in this document as COM1.



This icon is the symbol for radio transmission and identifies the radio communications port on the side of the Radian IS receiver. The radio communications port is also referred to in this document as COM2.





This icon is a symbol for supplied-power and identifies the power port on the side of the Radian IS receiver. The radio communications port is also referred to in this document as PWR.



This icon is the symbol for the power button and identifies the location of the power button on the display panel of the Radian IS receiver.

-  This icon is a symbol for battery and identifies the gauge that displays the battery life as well as the battery status indicator. This icon is located on the front display panel of the Radian IS receiver and inside your Radian IS access door.

-  This icon is a symbol for satellite and identifies the gauge that displays if you have achieved satellite lock. This icon is located on the front display panel of the Radian IS receiver.

-  This icon is a symbol for data card and identifies the gauge that displays the amount of free space remaining on your data card as well as the data card status indicator. This icon is located on the front display panel of the Radian IS receiver and inside your Radian IS access door.

-  This icon is a symbol for occupation time and identifies the period of continuous data of sufficient quality for post-processing. This icon is located on the front display panel of the Radian IS receiver.

1.3 Features

The Radian IS is capable of the following positioning modes of operation:

- Position and observation information
- Navigation information
- Transmit RTK data
- Receive RTK data (2 cm (0.8 in) positioning)
- DGPS (< 1m (< 3.28 ft)) transmit and receive

The Radian IS features are summarized in Table 1. For detailed information, see Appendix A, **Radian IS Specifications**.

Table 1: Feature Summary

Radian IS Features
General
Rugged shock resistant, water proof (when access door is closed securely), buoyant enclosure
Wireless controller interface
L1/L2 GPS technology (L1 Channels (C/A code) & L2 Channels (P code))
Capability to log data to a removable data card (CompactFlash card)
Low power consumption (4 W typical)
Scheduled data collection for when user interaction is not required (low power "off" mode between scheduled data collection sessions)
Patented PAC™ (Pulse Aperture Correlator) technology
Two bi-directional serial ports that have power/data support and can transfer data at rates up to 115200 bps (bits per second)
Pseudorange measurements
Full-wavelength L1 and L2 carrier measurements
Ionospheric corrections in position calculations
2.5-bit sampling
5 Input / Output strobe signals: mark input (position & time), 1PPS timing output, measure output, programmable variable-frequency output, solution status output
Fast re-acquisition
Peripheral power supply output COM1 and COM2
Output Data Log Formats
Proprietary ASCII and binary
CMR Standard
NMEA Standard
RINEX Standard
RTCM Standard: Types 1,2,3,9,16,18/19,59N
RTCA Standard: Types 1,7
Data Logging Rates (per second)
<i>Computed Data:</i> Position, speed, direction, & clock offset = 10
<i>Measured Data (Observations):</i> Pseudorange & carrier phase = 10

Radian IS Features	
Receiver Control	
	Clock drift correction
	Ability to save receiver configuration settings, & almanac
	Reset (hardware or software activated)
	Serial port control
	Datum (table or user-definable)
	Magnetic variation correction
	Undulation (table or user-definable)
	Position, height & velocity constraints
	Satellite lockout, elevation cut-off and health control

☒ **Note:** Specifications are subject to change without notice.

1.4 Where to Find Information

This manual provides sufficient information to allow you to effectively use the Radian IS. In addition to this manual, several other forms of documentation serve as supporting documents.

- **Radian™ IS Jump Start.** This document provides general Radian IS setup procedures. Using this document, you should be able to correctly and quickly setup your Radian IS.
- **Radian™ IS Quick Reference Card.** This card is a guide providing “quick” information on running the equipment in the field.
- **Radian™ IS Advanced Reference Materials.** Located as <http://www.sokkia.com/support>. This document, available in electronic copy over the Internet, lists the Radian IS cable and pinout specifications. As well, this document contains an advanced glossary of definitions.
- **Planning Reference Manual.** This document shows how to use *Planning* software to help determine satellite availability as well as information for understanding and setting schedules and configurations for Radian IS.
- **Spectrum® Survey Suite Reference Manual.** This document provides information for processing and adjusting your collected data.
- **SDR® Level 5 User/Reference Manuals.** These documents provide information for using the SDR Level 5 software.

1.5 Obtaining Technical Assistance

When contacting customer support, have available:

- the firmware version number
- a concise description of the problem

Technical support for this product is available from the distributor where you purchased it. You also may contact one of the Sokkia subsidiaries listed below.

Europe

Sokkia B.V.
Businesspark De Vaart
Damsluisweg 1, 1332 EA Almere
P.O. Box 1292, 1300 BG Almere
The Netherlands
Phone 036-53-22-880
Fax 036-53-26-241

New Zealand

Sokkia New Zealand
20 Constellation Drive
Mairangi Bay, Auckland 10
C.P.O. Box 4464
Auckland, New Zealand
Phone 64-9-479-3064
Fax 64-9-79-3066

Central & South America

Sokkia Central & South America
1200 NW 78 Avenue, Suite 109
Miami, FL, USA 33126
Phone 1-305-599-4701
Fax 1-305-599-4703

USA

Sokkia Corporation
16900 W 118th Terr
Olathe, KS, USA 66061
Phone 1-800-257-2552
Fax 1-913-492-0188

Canada

1050 Stacey Court
Mississauga, Ontario
L4W 2X8 Canada
Phone 1-905-238-5810
Fax 1-905-238-9383

Australia

Sokkia Pty. Ltd.
Rydalmer Metro Centre
Unit 29,38-46 South Street
Rydalmer NSW 2116
Australia
Phone 61-2-9638-0055
Fax 61-2-9638-3933

U.K.

Sokkia Ltd
Electra Way
Crewe Business Park
Crewe, Cheshire, CW1 1ZT
United Kingdom
Phone 01270-250525
Fax 01270-250533

Africa

265 Von Willich Ave.
Centurion, 0157
Republic of South Africa
Phone 27 12 6637999
Fax 27 12 6637998

Asia

Sokkia Singapore Pte. Ltd.
401 Commonwealth Drive
#06-01 Haw Par Technocentre
Singapore 149598
Phone 65-479-3966
Fax 65-479-4966

1.6 Notes, Cautions, and Warnings

Notes, Cautions, and Warnings stress important information regarding the installation, configuration, and operation of the Radian IS receiver.

-
- ☒ **Note:** Notes outline important information of a general nature.
-

CAUTION

Cautions inform of possible sources of difficulty or situations that may cause damage to the product.

WARNING

Warnings inform of situations that may cause you harm.

1.7 Radian IS Usage Cautions

CAUTION

- This device incorporates circuitry to absorb most static discharges. However, severe static shock may cause inaccurate operation of the unit. Use anti-static precautions where possible.
- This device is a precision instrument. Although it is designed for rugged operating conditions, it performs best when handled with care.
- When the access cover for Radian IS is closed and latched, and the port covers are closed, the enclosure is sealed to provide protection against adverse environmental conditions. To minimize the possibility of damage, always keep the access door closed and latched except when exchanging data cards or batteries and keep the ports covered except when in use.
- Do not eject the data card while the Radian IS is logging data, or you may lose part of, or your entire, data file.
- The Radian IS can accept an input supply voltage in the range +9 to +18 V DC. This may not be the same range as other Sokkia products with which you are familiar. Do not operate the Radian IS outside the specified voltage range.
- Drawing more than the specified maximum current (1 amp combined total) from the two COM ports will cause an internal fuse to interrupt the current. If this happens, immediately reduce the load and allow the unit to automatically reset its protection circuitry.
- We recommend that you do not use the Radian IS on a moving vehicle.

2.1 Getting Started

Setting up the Radian IS is a straightforward process, whether you are in the field (collecting data) or back at the office (configuring the Radian IS, or transferring collected data to your PC for post-processing).

CAUTION

See Section 1.7, *Radian IS Usage Cautions*, on Page 9 for a list of items you should be aware of as you set up and use the Radian IS.

2.1.1 *Setting up at the office*

For information on setting up your rover or base Radian IS, refer to the setup steps in your *Radian IS Jump Start*.

A typical Radian IS setup at the office may be when the PC is connected to the Radian IS COM1 port and internal batteries are powering the Radian IS. An office setup can be used to load a schedule on the Radian IS using Planning software, or to transfer collected data from the Radian IS to a PC.

Perform the following steps to setup Radian IS in the office:

1. Place the Radian IS on a desk or other suitable work surface.
2. Using the PC Data cable, connect the PC to COM1 on the Radian IS.
3. If not already installed, connect the Radian IS internal batteries to the internal battery connectors.

4. Turn on the Radian IS.
5. Communicate with the Radian IS, using the *Planning* software (Refer to your *Planning Reference Manual*), to setup configurations or setup a data-collection schedule. Use any Sokkia software to transfer data to the PC (For example, *Spectrum Survey*).

The sections of *Chapter 3, Radian IS Components*, give further details on Steps two and three, while *Chapter 4, Using the Radian IS*, will discuss Step four.

2.1.2 Setting up in the field

The Radian IS can be used for static or kinematic survey, as a base or rover. This section will give an overview of the equipment and setup for typical uses of the system, but for information on setting up your Radian IS for field operations, refer to the setup steps in your *Radian IS Jump Start*.

2.1.2.1 Typical static setup

For static survey, the Radian IS is put on a fixed height tripod or on a traditional tripod with a tribrach and adapter. The system is operated using the power switch or using a handheld through a wireless or cable connection. The system is powered using internal batteries or optionally a larger external battery.



Figure 1: Illustration of typical static setup

2.1.2.2 Typical base setup

An RTK base station setup will typically consist of a standard wood tripod or fixed height aluminum GPS tripod, Radian IS receiver, PDL radio/modem, radio antenna mount/cable, and antenna and radio antenna mounting bracket. The base system is typically powered by a large external battery (SLA battery) that powers both the radio and the Radian IS. Typically the base radio will hook onto the tripod and the base battery will sit on the ground.

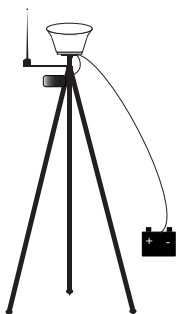

Figure 2: Illustration of typical base setup

2.1.2.3 Vehicle base setup

Radian IS may be mounted on a vehicle and used as a base. Typically the Radian IS and the radio antenna may be screwed onto magnetic mounts attached to the roof of a vehicle. The Radian IS may be powered through the cigarette lighter in the vehicle.

While it is convenient to use your Radian IS mounted to a vehicle for the base station, small movements caused by getting into and out of the vehicle, as well as wind and terrain conditions can cause small or very slow movements to occur, which will translate to an error of equal proportion at the rover's location. Only mount your Radian IS on your vehicle if

you know that you will not be getting in and out of your vehicle, or if the small amount of error caused is acceptable for your purposes.

For a base configuration, you must not move the vehicle during operations.

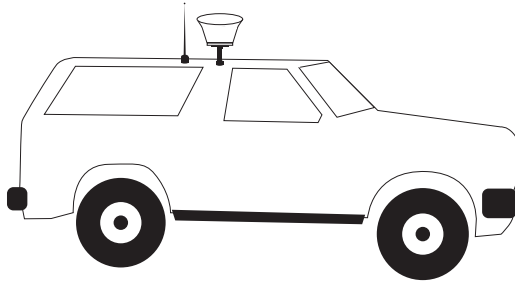

Figure 3: Illustration of vehicle setup

CAUTION

We recommend that you **do not use the Radian IS on a moving vehicle.**

2.1.2.4 Typical rover setup

A typical rover RTK setup consists of an adjustable pole, a PDL radio/modem, whip antenna, Radian IS receiver, controller bracket and controller. Typically the PDL and Radian IS mount on the top of the pole and the handheld bracket will attach near the mid-section of the pole with the handheld controller

attached. If the system is to remain standing, a bipod can be attached to the pole. The typical rover setup would not require the use of a backpack.



Figure 4: Illustration of typical RTK rover setup

The Radian IS enclosure houses your system's antenna, power supply, memory and GPS card. By incorporating these components into a single unit, a backpack is no longer needed when using the system.

3.1 Enclosure Feature Overview

The Radian IS enclosure has a single access door, providing easy access to the batteries and data card. For more information on the access door, see Section 3.2, *Access Door*, on Page 17.

As well, three ports, featuring easy-to-open, permanently attached covers, are accessible from the side of the unit. For more information on the ports, see Section 3.3, *Ports*, on Page 22.

Refer to Figure 5 for a view of the access door and the ports with covers attached.



Figure 5: Ports and single access door

The underside of the Radian IS enclosure has a standard 5/8" mounting socket for mounting the Radian IS on a tripod or survey pole. Refer to Figure 6 for a view of the mounting socket.



Figure 6: Mounting socket

The top of the Radian IS is the antenna, and it is surrounded by a brightly colored rubber bumper. For more information on the antenna, see Section 3.5, *GPS Antenna*, on Page 25.

The side of the Radian IS has a display panel that enables you to turn on and monitor the system. Brightly colored LEDs display the status of your system and alert you to errors when possible. For more information on the display panel, see Section 3.6, *Display Panel*, on Page 26.

Refer to Figure 7 for a view of the antenna and display panel.



Figure 7: Display panel and antenna

3.2 Access Door

The Radian IS access door provides easy accessibility, without the use of tools, to the data card and batteries. For information on inserting and removing the data card and batteries, see Section 3.2.2.1, *Inserting and removing the data card*, on Page 19 and Section 3.2.3.1, *Inserting and removing the battery*, Page 21. As well, three status indicators providing information about the internal batteries and data card are visible from inside this compartment (See Section 4.3, *Internal Status Indicators*, on Page 38). Refer to Figure 8 for a view of the access door and compartment.

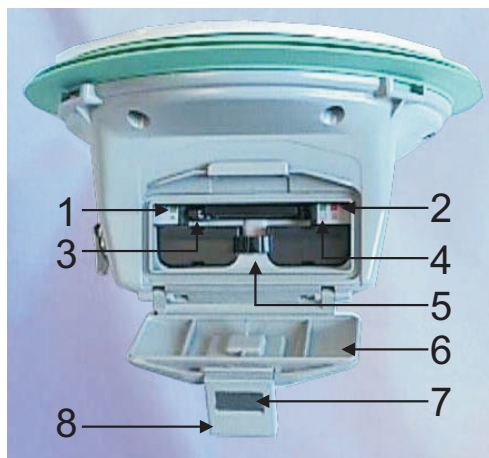

Figure 8: Access door open

#	Description	#	Description
1	Battery A status indicator	5	Battery clip and release
2	Battery B status indicator	6	Access door
3	Data card eject	7	Latch release
4	Data card status indicator	8	Access door handle

3.2.1 Opening and closing the access door

To open the access door, simply press down on the grey latch release and let go. The access door will spring open. Lift up on the access door handle to gain access to the two battery compartments and the data card compartment. You now have full access to the Radian IS internal batteries and data card.

To close the access door, use the handle to lift the door back to its closed position. Insert the lip of the connector end of the access door handle into the slot at the top of the Radian IS access door opening. Push the access door handle down into the space on the outside of the access door until you hear a click. Your Radian IS access door is now closed and the batteries and data card are sealed into the waterproof compartment.

Figure 9 shows the Radian IS access door in its closed and open position.



Figure 9: Access door closed and open

3.2.2 Data card

Data can be stored on a CompactFlash data card; a memory card which you can access, exchange and replace when needed. The need for a companion handheld data collector is unnecessary when continuous user interaction is not required because the Radian IS is capable of collecting data according to pre-configured parameters without any user intervention (see Section 4.5.2.2, *Using the POWERUP configuration*, on Page 47). In applications when continuous user interaction is required, the data collector can be used with Radian IS.

The access door on the Radian IS provides a dust and waterproof seal around the data card compartment (see Section 3.2, *Access Door*, on Page 17). The access door handle must be secured snugly in order for the access door to seal properly. When the access door is closed and secured, the enclosure is sealed to provide protection against adverse environmental conditions.

WARNING

To minimize the possibility of damage, always keep the access door closed and secured except when exchanging data cards or internal batteries.

The socket on the Radian IS accommodates one CompactFlash data card. Only 5 V compliant CompactFlash modules are supported.

Data cards can be swapped while the Radian IS is on, providing that data logging is not in progress. For information on data card status, refer to Section 4.3.1, *Data card indicator*, Page 39.

The Radian IS is supplied with a CompactFlash data card, but you have the flexibility of choosing the data card with the storage capacity that is the most appropriate for your needs, based on the selected data collection rate. The Radian IS has been tested with SanDisk ATA-Type CompactFlash 8 MB, 20 MB, 40 MB and 80 MB data cards.

3.2.2.1 Inserting and removing the data card

When the access door is open, you have unobstructed access to the data card compartment. For a view of the open access door, see Section 3.2, *Access Door*, on Page 17.

To insert the data card, ensure that the logo side of the card is face-up, and the card is correctly aligned before gently sliding it into the slot. When the card slides all the way in and locks in place, the eject button, located to the left side of the data card

compartment, will extend. If you attempt to insert the card incorrectly, the card will not go all the way in, and the eject button will not extend. In this case, do not force the card! Remove it, orient it properly, and then re-insert it. After the card is locked in place, close the access door.

To remove the data card, open the Radian IS access door to gain access to the card. When the door is open, you will see an eject button to the left of the card. You must push this button to partially eject the card; then grasp the card and pull it all the way out.

The data collection mechanism is designed to be robust and to endure power interruptions (and similar disruptive events) with minimum loss of data. In these situations, less than 5 minutes of data (prior to the disruptive event) are lost. When possible, error messages are generated to identify problems as they arise.

CAUTION

Ejecting the data card during a data-recording session will cause data to be lost. If the memory LED inside the compartment is flashing, you know that data is being recorded to the card. When no data is being recorded, however, it is not necessary to turn the Radian IS off before inserting or extracting a data card.

3.2.3 Battery

The Radian IS incorporates two internal Sokkia BDC46 Li-Ion batteries (or equivalent).

While one of the internal batteries is powering the Radian IS, the non-active internal battery can be replaced without disrupting operation of the Radian IS. For information on inserting and removing a battery, see Section 3.2.3.1, *Inserting and removing the battery*, on Page 21.

The battery located in position A of the battery compartment in the Radian IS is always discharged first before the system will switch to the power supplied by the battery located in position B. Each battery compartment has an associated LED light that indicates if the battery in that compartment is in use (green blinking LED). If the battery is not in use, or the battery is drained, the LED will not illuminate or blink. For more information see Section 4.3.2, *Battery indicator*, on Page 39.

-
- ☒ **Note:** Before placing a battery into the Radian IS, use your battery charger to ensure that it is fully charged. The Radian IS assumes that when you install a battery into the battery compartment, it is fully charged. If the battery is not fully charged when inserted, the battery gauge on the front panel of the Radian IS will report the battery status incorrectly.
-

To recharge an internal battery, remove it from within the Radian IS. Follow the instructions provided with your battery charger.

If you connect the Radian IS to an external power source such as a battery or electrical outlet, the external power input must be terminated (dead battery or power failure) before the Radian IS will switch to internal battery power.

3.2.3.1 Inserting and removing the battery

When the access door is open, you have unobstructed access to the internal battery compartments. For a view of the open access door, see Section 3.2, *Access Door*, on Page 17.

To insert a battery into the Radian IS, open the access door. Two compartments are located within the Radian IS for housing internal batteries. Between the two compartments are two battery clips that hold the batteries into place within their compartments. For a view of the battery clips, see Figure 8, *Access door open*, on Page 17.

Hold the internal battery curved-side down and with the back of the battery facing the back of the battery compartment (the end of the battery with the metal connectors is the back). Slide the battery into its compartment. When the battery is securely in place, the battery clip will click into place. If you attempt to insert the battery incorrectly, the battery will not go all the way in, and the battery clip will not click. In this case, do not force the battery! Remove it, orient it properly, and then re-insert it. After the battery is locked in place, close the access door.

To remove the battery, open the Radian IS access door and locate the two battery clips between the two battery compartments. Push the battery clip, holding the battery you wish to remove, away from the battery. The battery will spring out of the battery compartment enough to enable you to grasp the battery and pull it all the way out.

-
- ☒ **Note:** Ensure that you only push the clip that is holding the battery you wish to remove. If you squeeze both clips at the same time, you will not be able to remove either battery.
-

For a graphical representation of this process, refer to your *Radian IS Jump Start* for instructions.

3.3 Ports

The Radian IS features an external power port and two communication ports. All ports are located on the side of the enclosure and are protected by covers that should not be open unless the port is in use. The covers are permanently attached to the Radian IS enclosure.

The Radian IS ports enable input and output power as well as communication with the system.

All ports are labeled with icons and text for easy identification. The following is an illustration of the ports and the labeling:

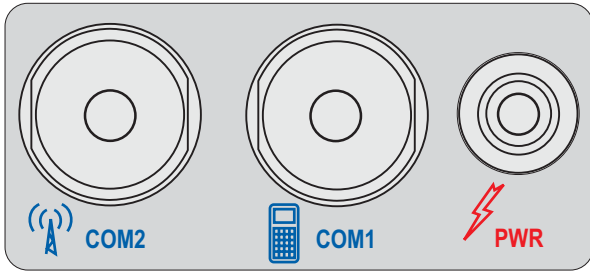

Figure 10: Ports

Each Radian IS cable port is keyed to ensure that the cable can be inserted in only one way, to prevent damage to both the Radian IS and the cables. Furthermore, the port connectors that are used to mate the cables to the Radian IS have a locking mechanism that requires careful insertion and removal. Observe the following when handling the cables.

- To insert a cable, make certain you are using the appropriate cable for the port (For example, the power cable has a different connector than the communications cable).
- Line up the red dot on the connector shell with the red index mark on the receptacle on the Radian IS.
- Insert the connector until it seats with a click; it is now locked in place.
- To remove a cable, grasp the connector by the knurled ring and pull.

CAUTION

Do not pull directly on the cable.

For more information on the Radian IS port and cable specifications, refer to the *Radian IS Advanced Reference Materials*.

3.3.1 Power port and power input

The Radian IS has one power port for connecting an external power source to the Radian IS.

The power port enables you to power your Radian IS using an external power source, such as a large external battery. This is an alternative to using the Radian IS internal batteries. Refer to Section 3.2.3, *Battery*, on Page 20 for more information on the internal batteries.

The operation of the Radian IS is dependent on a power source connected to the system (internal or external). If there is no power source connected, the Radian IS will not work.

For the Radian IS to operate with an external power source, the minimum operating voltage for the external power input can not be below the minimum Radian IS operating voltage. Please see *Radian IS Specifications* on Page 51, for detailed information on the Radian IS operating voltage.

Radian IS is designed to be protected against the reverse-polarity connection of an external supply and against over-voltage and noise from an external source.

3.3.2 Communications ports and power output

The Radian IS communication ports enable you to communicate with accessory devices, such as the data collector or the radio. As well, each communication port provides a battery output for powering accessory devices.

Typically, the COM1 port of the Radian IS is intended for use with the data collector and the COM2 port is intended for use with a radio.

The Radian IS provides battery power output through the COM1 and COM2 ports for powering accessories. The power output is approximately the same as the input of the active battery to within ten percent.

If the peripheral devices attached to the Radian IS try to draw too much power from the battery output, the Radian IS will limit the current available to prevent damage to the receiver. Once the excessive load is removed from the Radian IS, normal operation of the system will resume. If you use the Sokkia recommended data collector (SDR Level 5) and radio, you will not overload your system. This possibility only exists if you attach peripherals that have not been tested with the Radian IS.

3.4 Wireless Communications

The Radian IS enables you to transfer data up to approximately 6 m (20 ft) from the receiver to the data collector via a wireless communications port.

3.5 GPS Antenna

The Radian IS features an integrated antenna with Pinwheel Technology™. This revolutionary antenna gives the performance of a choke ring.

Using Pinwheel Technology, the Radian IS can achieve less than 1mm offset between L1 and L2 phase centers without the aid of a choke ring. As a result of such little offset, there is no need to orientate the antenna to one particular direction.

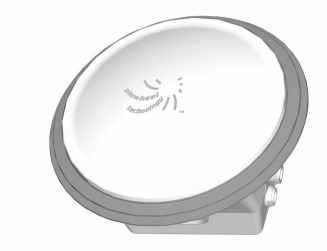

Figure 11: Antenna

There are several points around the circumference of the receiver where the antenna height can be measured (in other words, a tape measure anchor point or a point which a tape measure can be laid against).

The height measurement locations on the enclosure enable the use of a Sokkia tape measure (custom tape with offset scale and reference tip) or a typical hardware-store tape measure.

3.6 Display Panel

The Radian IS has a display panel to provide you with a view of your system and to alert you of errors when possible. The display panel features the following:

- Power button
- Message beeper
- Four gauges

The following is an illustration of the panel:

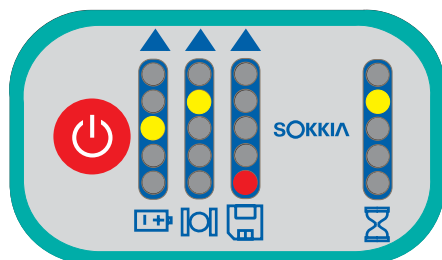

Figure 12: Panel display

The display panel provides optimal visibility for both the office and in the field. As well, prominently placed icons enable you to quickly identify each gauge. See Section 4.2, *Display Panel Operations*, on Page 31, for an explanation of the options on the display panel.

Before using the Radian IS for the first time, ensure that you have followed the set-up instructions in your Radian IS Jump Start and *Chapter 2, Setting-Up The Radian IS*.

CAUTION

See Section 1.7, *Radian IS Usage Cautions*, on Page 9 for a list of items of which you should be aware as you use the Radian IS.

4.1 Power Supply and Control

In this chapter, all discussions about the Radian IS being off are with the understanding that the Radian IS is still connected to a power source (internal batteries or external source).

The following sections explain how to supply power to your Radian IS. As well, the sections discuss how to use your Radian IS to both manually and automatically collect data.

4.1.1 Turn system on

The Radian IS receiver has a power button that, when pushed, will turn on or off the Radian IS receiver and system peripherals. For more information on the power button see Section 4.2.1, *Power button*, on Page 31.

4.1.2 System inactivity

The Radian IS will automatically shut off if left inactive for a period of five minutes (in other words, if there is no COM port activity and no data recording). The Radian IS will remain off unless the time arrives for a scheduled session to begin, if the

Radian IS detects COM port activity or if the power button is pressed. If either happens, the Radian IS will automatically turn back on.

4.1.3 Scheduled session

If the Radian IS is off, but you scheduled a session for logging, the receiver will indicate that it is aware of the schedule by slowly flashing the bottom LED of the occupation time gauge. For more information on the occupation time gauge, see Section 4.2.3.4, *Occupation time gauge*, on Page 38.

To better understand this concept, you should know that the reason the GPS receiver can turn off between data-collection sessions is because of a powerful clock, synchronized to GPS time, located inside the Radian IS (see *Real-Time Clock*, on Page 52). This clock acts like an alarm to wake the Radian IS (in other words, turn it back on) five minutes before a schedule is to begin.

4.1.4 Data logging interruption

If you press the power button to turn the Radian IS off while it is logging data autonomously, the Radian IS will save any open data files before turning off.

4.1.5 Power source

The Radian IS incorporates two internal Sokkia Li-Ion batteries (or equivalent). For information on the batteries, see Section 3.2.3, *Battery*, on Page 20. The Radian IS can also be powered using an external power source such as a car battery. For information on the external power source, see Section 3.3.1, *Power port and power input*, on Page 24.

The Radian IS provides power to peripheral devices through its COM ports. For more information on output peripherals, see Section 3.3.2, *Communications ports and power output*, on Page 24.

4.1.6 Power consumption

In order for the Radian IS to perform some of its important automatic features such as turning on to run schedules and detecting COM port activity, it must be connected to a valid power supply. The automatic features depend on internal components of the Radian IS (such as the internal clock) to be constantly working. As a result, when the Radian IS is off, the receiver will consume a small amount of power in order to maintain automatic operation.

The Radian IS has been designed to minimize its power usage, which is especially important when the system is set to conduct scheduled data-collection sessions over a period of several days, using its internal batteries. For automatic data collection, the Radian IS will turn on early enough so that satellite tracking is established prior to the scheduled logging session, stay on for the logging session and turn off when the session is complete.

☒ **Note:** Exceptional conditions may delay the acquisition of satellites beyond the start of the logging session.

If you turn off your Radian IS, but leave it connected to its batteries, the system will continue to draw a small amount of power from the batteries. After several weeks, the batteries will be discharged. If this happens, simply recharge the batteries to resume operation.

☒ **Tip:** If you do not want the Radian IS to monitor its ports or draw power, you can extend the life of your internal batteries by removing them from the Radian IS when the system is not in use.

4.1.7 **Insufficient power**

If either the internal batteries or the external power input voltage are below minimum operating parameters (in other words, if the Radian IS experiences drained batteries or power failure) the Radian IS will turn off and become inactive.

If this happens, the Radian IS will not be able to turn back on until proper power is restored.

In the event of power failure, the Radian IS power output is disabled on both COM ports and the Radian IS will not resume operations for COM activity or even if the power button is pressed.

To return to normal operation, charge the internal batteries or connect a valid external power input to the Radian IS. When sufficient power is resumed, the COM ports will provide power (if they did before the power failure), and the system will automatically turn on when it detects COM activity or if the power button is pressed.

CAUTION

The Radian IS may also become inactive if the external power input is greater than the power specified. See Section 1.7, *Radian IS Usage Cautions*, Page 9 for more information.

4.2 **Display Panel Operations**

The following sections explain the operation of the options on the Radian IS display panel.

4.2.1 **Power button**



The Radian IS power button is used for turning the Radian IS on or off. As well, the power button will enable you to delete all files on your data card or reset the receiver back to factory settings.

The number of seconds that the power button is held depressed determines how the receiver will behave. As well, at each time interval, the receiver will beep to guide you through the process. For more information see Section 4.2.2, *Audible annunciator*, on Page 33.

The power button options are as follows:

Action	# Seconds	Description
Turn on	1	Hold button for 1 second and release to turn the Radian IS on. To indicate that the Radian IS is on, the first battery LED will illuminate. During initialization the display panel gauges will all flash. After initialization, the Radian IS will beep once to indicate that the system is operational.
Turn off	3	Hold the button for 3 seconds until the Radian IS beeps twice and the middle three internal battery life gauge LEDs illuminate. Release the button to turn the Radian IS off.
Factory reset	10	With the Radian IS turned on, hold the power button for 10 seconds until the Radian IS beeps twice (for the second time) and the middle LEDs on the internal battery life, satellites visible tracking and data card memory gauges illuminate. Release the button to reset all stored parameters on the receiver to their default values. Note that you must release the button before 15 seconds or the reset will not be activated.
Erase memory	20	With the Radian IS turned on, hold the button for 20 seconds until the Radian IS beeps twice (for the third time) and the middle data card memory gauge LEDs illuminate. Release the button to delete all the files on the installed data card.
Disregard	25	If you hold the button past 25 seconds , nothing will happen, and the receiver will return to normal operations. The receiver will not turn off, the data files will not be erased and the settings will not revert to factory settings.

4.2.2 Audible annunciator

The Radian IS is equipped with an audible annunciator which issues a series of beeping noises to alert you to the system status and to warn of errors when possible.

The beeps may be for a single duration (means one beep pattern when the condition first occurs) or continuous (means the beep pattern will repeat itself for as long as the condition persists).

As well, the severity of the situation is indicated by the number of beeps. Information that is noteworthy will be presented to you with one or two beeps. A warning is indicated by three beeps, and an error is indicated by four beeps. When you hear a three or four beep pattern, check your system right away.

The annunciator will indicate the following conditions:

# of beeps	Duration	Condition
1	single	receiver on and ready for operation, initiated whenever you initially press the power button to turn the receiver on (see Page 28)
2	single	receiver is turning off, initiated by pressing power button (see Page 31)
2	single	data card erase, initiated by power button pressed (see Page 31)
2	single	factory reset, initiated by power button pressed (see Page 31)
2	single	acceptable data quality
3	single	insufficient data quality
3	continuous	remaining battery life is below 15 minutes
3	continuous	the memory card more than 80% full
4	continuous	memory card error
4	continuous	power button stuck

4.2.3 Gauges



The Radian IS display panel features four gauges to provide information about your Radian IS. The function of the gauges is to display information on the following:

- Internal battery life
- Satellites used
- Data card memory available
- Occupation time (period of continuous data of sufficient quality for post-processing)

Each gauge contains a series of five LEDs that glow to alert you of system operations. The top four LEDs glow yellow and the bottom LED glows red with the exception of the occupation time gauge which has all yellow LEDs.

☒ **Note:** During typical operation, only one LED will be on in each gauge at any one time.

4.2.3.1 Internal battery life gauge



The internal battery life gauge displays the battery life remaining on your internal batteries. Battery life is calculated to an accuracy of approximately 30 minutes.

If you decide to power your Radian IS using an external battery source, such as a car battery, the top LED in the gauge will blink.

☒ **Note:** Radian IS will not calculate the remaining battery life of an external power input supply. Battery life is only calculated for internal batteries. As well, it is assumed that you are installing fully charged batteries. For this gauge to report battery status correctly, always install fully charged batteries into the Radian IS.

In normal operation, the battery life gauge will have the following values, where time = T, from top to bottom:

- $4 \text{ hrs} \leq T$
- $3 \text{ hrs} \leq T < 4 \text{ hrs}$
- $2 \text{ hrs} \leq T < 3 \text{ hrs}$
- $1 \text{ hrs} \leq T < 2 \text{ hrs}$
- $0 \text{ hrs} \leq T < 1 \text{ hr}$

When both batteries are completely charged, and you have not used any of the internal battery power, the top LED will glow yellow.

When you begin to use your internal batteries, the LED associated with the amount of remaining battery life will glow yellow. For example, when you have full power (four hours), the top LED is illuminated, then when you have less than four hours remaining on your battery life, but at least three hours, the second to top LED will glow yellow and the top LED will no longer glow.

The bottom LED is colored red. When the red LED is the only one illuminated you know that you have less than one hour of battery power remaining.

4.2.3.2 Satellites visible tracking gauge



The satellite usage gauge will display information once the position of the Radian IS has been fixed.

For a satellite to be counted as used, it must have a healthy signal, be above the elevation mask and the receiver must have achieved lock (both carrier and code).

In normal operation, the satellites usage tracking gauge will have the following values, where SU = satellites used, from top to bottom:

- 10, 11 or 12 SU
- 8 or 9 SU
- 6 or 7 SU
- 4 or 5 SU
- 1, 2 or 3 SU

For the most accurate survey results, you should not survey unless you are using a minimum of six satellites. A yellow LED indicates that you are successfully using the number of satellites associated with that LED.

The bottom LED is red and illuminates if the receiver is using only one, two or three satellites. Because using such a small number of satellites will not give you accurate results, this LED is red to remind you not to collect data at this time.

4.2.3.3 Data card memory gauge



The data card memory gauge displays the amount of memory or space used on your data card.

When your data card has over 80% space available, the top LED will glow yellow. As you use the space on your data card, the LED associated with the amount of space left on your card will illuminate. The bottom LED is red to indicate to you that the data card is almost completely filled. Once the LED glows red, you should consider replacing the current data card with an empty card or delete the files.

In normal operation, the data card memory gauge will have the following values, where S = space available, from bottom to top:

- $100\% \geq S > 80\%$
- $80\% \geq S > 60\%$
- $60\% \geq S > 40\%$
- $40\% \geq S > 20\%$
- $20\% \geq S$

When a file is opened on the data card, the data card compartment LED will blink green (for a view of the data card LED, see Figure 8, *Access door open*, on Page 17).

☒ **Note:** if a non-recoverable error occurs when data is being written to the data card, all the LEDs in the data card memory gauge will blink simultaneously.

4.2.3.4 Occupation time gauge



The occupation time gauge displays that sufficient data has been collected for successful post-processing for the indicated baseline. If an LED is illuminated yellow, you can process your data to the baseline corresponding to the illuminated LED.

The occupation time gauge also informs you of impending schedules and receiver errors. If the Radian IS is off, and a schedule is set to turn on at a later time, the bottom LED of the gauge will blink slowly until the schedule begins or until you disconnect power from the Radian IS. As well, if the Radian IS experiences an error resulting in it not being able to turn on, the bottom LED of this gauge will blink quickly.

In normal operation, the occupation time gauge will have the following values, from top to bottom:

- 30 km baseline
- 20 km baseline
- 15 km baseline
- 10 km baseline
- 5 km baseline

4.3 Internal Status Indicators

Three LED status indicators, visible after opening the Radian IS access door (See Section 3.2, *Access Door*, Page 17), glow green to provide information about the status of the data card and the internal batteries. The LED status indicators are explained in the following sections.

4.3.1 Data card indicator

The LED for the data card is indicated by the disk icon (see Figure 13). When the data card is in use (in other words, when a file has been opened), the LED blinks green; otherwise, it is off. Refer to Figure 8, *Access door open*, on Page 17, to see the location of this LED.



Figure 13: Data card indicator

4.3.2 Battery indicator

There are two battery LEDs, one for each internal battery. The battery located on the left side of the compartment is battery A. The LED associated with battery A is indicated by both the battery icon (see Figure 14) and the letter A. The battery located on the right side of the compartment is battery B and is indicated by the battery icon and the letter B. Refer to Figure 8, *Access door open*, on Page 17, to see the location of these LEDs.

The battery A LED blinks green if battery A is active, and the battery B LED blinks green if battery B is active; otherwise, the LEDs are off.



Figure 14: Battery indicator

4.4 General Operations

Following is a list of general operations when using the Radian IS receiver, data collector and schedules:

- First, apply power to the Radian IS (in other words, install its internal batteries or connect it to an external power supply). Once a Radian IS is connected to a proper power supply, it is ready to use.

- Second, turn the system on by simply pressing the power button. The Radian IS will acquire GPS time and then automatically start collecting data based on commands in the POWERUP configuration if it exists (See Section 4.5.2.2, *Using the POWERUP configuration*, Page 47). At this point, any scheduled sessions you may have transferred to the Radian IS will be ignored because the existence of a POWERUP group overrides all other schedules.
- Third, if a POWERUP configuration does **not** exist, the Radian IS will check for scheduled sessions (For information on the scheduler, see Section 4.5.2.1, *Using receiver configurations*, on Page 46). In other words, if you used the *Planning* software to delete the POWERUP group from the receiver, you will have deleted the default start group. The second default for the system is that in the absence of a POWERUP group, the Radian IS checks to see if there are any schedules. If a schedule is found, and the schedule session is to start within the next five minutes, the Radian IS will remain on. If the schedule is not set to start until later, the Radian IS will conserve battery power by turning itself off until five minutes before the schedule is to start. To understand more about the Radian IS's ability to turn on for schedules, see Section 4.1, *Power Supply and Control*, on Page 28.

Overview:

- The Radian IS will follow commands in the POWERUP group and ignore all schedules if the POWERUP group exists on the receiver.
- As long as the POWERUP group exists on the receiver, you cannot run a schedule.
- If you want to run a schedule, you must use the *Planning* software to delete the POWERUP group from the receiver.

Figure 15 explains graphically how the receiver responds to the POWERUP group and schedules.

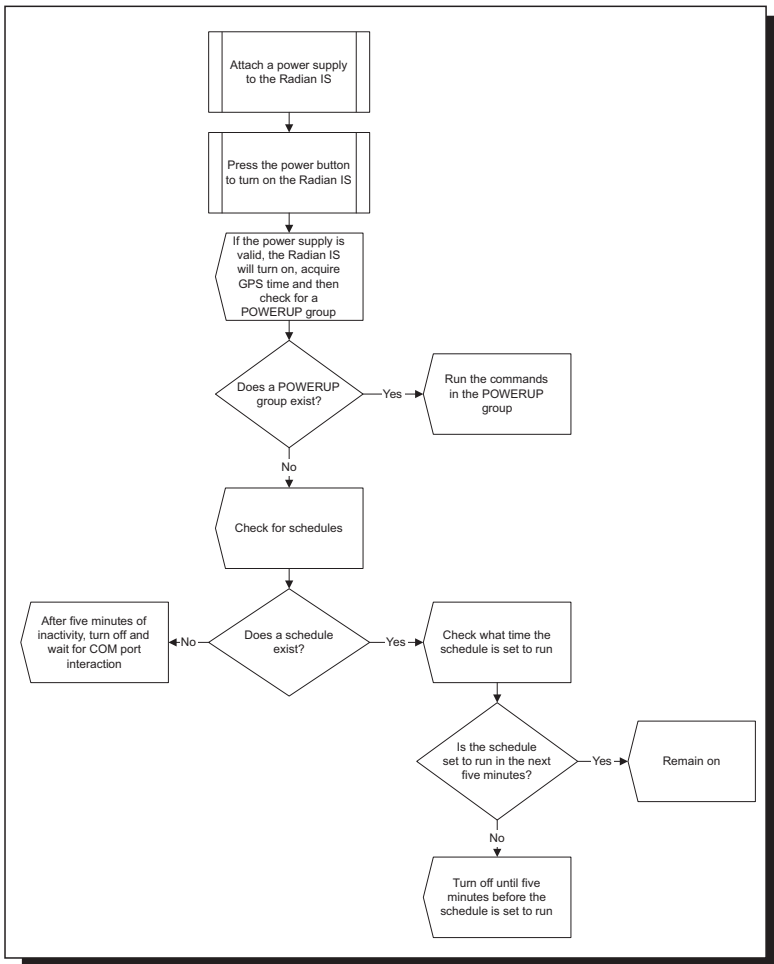

Figure 15: Radian IS general operations

If you are using a data collector, and you turn the Radian IS receiver on, you will disable all schedules when the data controller takes control of the receiver. Refer to your *SDR Level 5 User Manual*.

-
- ☒ **Note:** Receivers are intended to be used as kinematic or static but not both at one time. Run schedules only on Radian IS when it is being used as a static receiver (base station). If you need to enter any data on the base station receiver, do so in the office, using *Planning* software, before you go into the field. Never communicate with a base station receiver, using the SDR, if the receiver is set to run a schedule. Doing so will disable the schedule.
-

CAUTION

There is an option that will enable you to collect the data you require, as soon as the receiver is turned on, without having to delete the POWERUP group or create schedules. This option is to edit the POWERUP group to collect the data that you require instead of what was preset. Editing configurations is for advanced users only. Refer to your *Planning Reference Manual* for instructions.

4.5 Data Collection Fundamentals

The Radian IS receiver is an extremely versatile GPS device that enables you to collect data several ways and to define the type of information stored during data collection. The following sections explain data collection.

4.5.1 Collecting data

The most basic activity you will perform using your Radian IS is collecting raw data. Each collection session (one uninterrupted period of time) is stored in a single, unique file on a data card. This file can subsequently be transferred to a PC for post-processing and adjustment using Sokkia's Spectrum Survey Suite software package.

Radian IS records raw data in the form of logs, which are written to the data file on a periodic basis. Sokkia's software interprets these logs and the data that they contain.

The Radian IS receiver collects data in three ways:

- Handheld (SDR Level 5) data collection (see Page 43)
- Manual data collection (see Page 44)
- Scheduled data collection (see Page 44)

4.5.1.1 Handheld data collection

You can use the Radian IS receiver with a SDR Level 5 handheld controller to configure and initiate data collection. When you connect the SDR to the receiver, a communication link is established and the handheld controls the behavior of the receiver. If you turned the Radian IS on by pressing its power button, the POWERUP configuration, if it exists, will run until the SDR takes control of the receiver. Commands issued to the system through the SDR will supersede any configuration, such as POWERUP, that is resident on the receiver (See Section 4.5.2.2, *Using the POWERUP configuration*, on Page 47).

Use the handheld options in the *Instrument Setup* screen to determine whether data is stored on the receiver or on the SDR.

-
- ☒ **Note:** If you communicate with the Radian IS using the SDR, any scheduled sessions residing on the Radian IS will be disabled. To override the SDR, the receiver will have to be manually reset to the factory default configuration by holding the power button (See Section 4.2.1, *Power button*, Page 31). If you intend to transfer scheduled sessions to the Radian IS receiver, do not connect a SDR to the system. As long as a SDR has not been connected to the system, and therefore has not disabled the scheduled sessions, the sessions will start when scheduled.
-

4.5.1.2 Manual data collection

You can turn the receiver on by pressing the power button (see Section 4.2.1, *Power button*, on Page 31). Once the receiver has acquired GPS time, the Radian IS will automatically start collecting data based on the POWERUP definitions (See Section 4.5.2.2, *Using the POWERUP configuration*, Page 47). If the POWERUP group does not exist, the Radian IS will turn off until it is time to run a scheduled session or if it detects COM port activity.

4.5.1.3 Scheduled data collection

A schedule is a session of configurations that are set to run at a specified time (See Section 4.5.2.1, *Using receiver configurations*, on Page 46). Schedules allow you to quickly and easily setup different data collection sessions to run unattended in the field.

Data collection can be setup according to a pre-configured schedule that allows both repetitive events (For example, every day from 15:00 to 17:00) and custom events (For example, tomorrow from 10:00 to 11:00 and the day after from 17:00 to 18:00).

If a session is predefined or a manual session is started, a new file opens and the initial file closes. For information on pre-configured schedules, see Section 4.5.2.1, *Using receiver configurations*, on Page 46 and refer to your *Planning Reference Manual*.

☒ **Note:** Schedules are ignored by the receiver when it is first powered on if a POWERUP configuration exists on the receiver. If you want to run a schedule, you must use the *Planning* software to delete the POWERUP configuration from the receiver. You can find out more information on schedules by consulting your *Planning Reference Manual*.

The following are the guidelines for setting schedules:

- You can schedule data collection for up to seven days in a one-week period, with up to 35 sessions per day.
- The scheduler operates perpetually (For example, if an event is scheduled to occur on a Monday, this event is serviced every Monday that the system is in operation).
- Start and stop times must be provided with a resolution of 1 minute.
- The minimum time interval per data collection session is 5 minutes (300 seconds).
- If you do not provide file names in advance, a unique file name is automatically generated for each set of recorded logs (see Table Auto-Generated File Name Convention, on Page 49).
- Only one schedule can be active at any time.
- If there is sufficient time between sessions, the Radian IS will power off to conserve power (See Section 4.1, *Power Supply and Control*, Page 28).
- When setting schedules, you may not specify overlapping time intervals. All scheduled entries rely on day of the week and time references.

4.5.2 Defining data to be collected

You can define what type of information should be collected during a data collection session by using tools available in the Sokkia *Planning* software to create configurations for the Radian IS. The following sections give an overview of using configurations. For more information, refer to your *Planning Reference Manual*.

4.5.2.1 Using receiver configurations

Receiver configurations are groups or sets of data that tell your receiver what type of information should be stored during a data collection session. A configuration consists of the following:

Logs a list of what type of data to collect
(For example, ephemeris - rawephem)

Destination where the data should be stored (For example, data card, COM1 or COM2)

Interval..... when the data should be collected
(For example, every 10 seconds - onTIME 10)

The configuration can also identify position (none, fixed or averaged) and point information such as the antenna height and elevation mask.

Configurations are part of a session contained within a schedule that can be run manually or automatically (as setup in *Planning*).

You can add configurations to the receiver to identify different data collection methods and the associated types of information. Configurations are transferred to the receiver from the *Planning* software as part of a session inside schedules (refer to your *Planning Reference Manual* for information on setting up schedules). In short, create a configuration of the types of data you want to collect, add the configuration to a schedule where you specify when to collect the data and transfer the schedule to the receiver.

The *Planning* software provides several predefined configurations based on different data collection methods. You can simply select one of these predefined configurations (For

example, Static Survey) for your session, or you can define your own configuration (refer to the *Planning Reference Manual* for more information).

Schedules transferred to the receiver will be run by the receiver. If the receiver is off when the time approaches the beginning of a scheduled session (See Section 4.1, *Power Supply and Control*, Page 28), the receiver will power on five minutes prior to the scheduled event, establish GPS time and then run the schedule.

☒ **Note:** If the receiver is inactive because of insufficient power, schedules will not run.

4.5.2.2 Using the POWERUP configuration

The Radian IS receiver initially operates on a default configuration called POWERUP (for more information on configurations, see Section 4.5.2.1, *Using receiver configurations*, on Page 46 or refer to your *Planning Reference Manual*).

The POWERUP configuration is the Radian IS default configuration, and it is always present on the receiver unless you remove it using the *Planning* software. Although you can remove or change the POWERUP configuration using *Planning* software, resetting the receiver back to factory defaults will discard any changes and revert the POWERUP configuration back to factory settings (See Section 4.5.5, *Resetting the receiver*, Page 50).

When you look at the factory setup for the POWERUP configuration, you will notice that it consists of log names and recording intervals. Although configurations may look confusing, once you understand the meaning of the logs they are quite easy to setup.

The following is the factory setup for the POWERUP configuration and an explanation of the meaning of each log:

- range ontime 10.0** GPS data logged every 10 seconds
- rawephem onchanged** ephemeris data logged every time it changes
- almanac onchanged** almanac data logged every time it changes
- rtcaobs ontime 1.0** base station GPS data transmitted every second
- rtcaref ontime 10.0**..... base station position transmitted every 10 seconds
- avepos 0.025**..... the receiver will average its position for 0.025 hours (1.5 minutes) and then fix to this position

The first three logs (range, rawephem and almanac) are typically used for post processing and are logged to the data card. The last three (rtcaobs, rtcaref and avepos) are typically used for an RTK base station, and rtcaobs and rtcaref are transmitted to the radio out of COM port 2.

Though some of the logs in the POWERUP group are useful for post-processing and others are useful for a base RTK system, all logs work to your advantage because the Radian IS will perform as a static/kinematic receiver if a radio/modem is not present, or as an RTK base if the radio/modem is present. By including all necessary logs for either configuration into the one POWERUP group, you will not have to change the default logs if your Radian IS is switched between static and RTK base.

4.5.3 Data file naming

Although file name conventions are explained in this section, you must refer to your *Planning Reference Manual* for instructions on setting up a schedule.

When scheduling a single data collection event, you can provide a name for the data file in advance. If you are scheduling a series of events, you must allow Radian IS to generate names automatically.

An acceptable file name consists of up to eight characters, followed by a *.pdc extension. Auto-generated filenames consist of an eight-character base followed by a *.pdc extension. The eight characters are derived as shown in Table 2.

Table 2: Auto-Generated File Name Convention

#####.pdc	Comments
####	last 4 digits of the Radian IS serial number
\$\$\$	UTC day of the year (001 – 366)
%	session ID assigned in sequence (0.. 9, A.. Z) based on the presence of files previously logged on a particular day.

For example, a Radian IS might have a serial number such as:

CGN95450087

If the day is January 25, for example, and this is the 15th schedule created that day, then, being that the UTC day-of-year representation for January 25 is **025**, and the 15th schedule of the day would have an entry index of **E**, this file would have a name such as:

0087025E.PDC

Should a conflict occur between an auto-generated file name or a file name specified in a scheduled entry, the Radian IS will resolve the conflict by creating a file name whose first character is a tilde (“~”), followed by a 7-digit random number, and a *.PDC extension. For example

~9368412.PDC

4.5.4 Data storage requirements

Based on the POWERUP default settings, Table 3 displays the approximate number of hours of logging available using an 8MB CompactFlash data card at epoch rates ranging from 1-60.

Table 3: 8 MB Data Card Logging Capacity

Hours of Storage on the Radian IS							
Epoch	Average # of Satellites						
Rate	6	7	8	9	10	11	12
1	8	7	6	6	5	5	4
2	17	14	13	11	10	9	8
5	42	36	31	28	25	23	21
10	83	71	63	56	50	45	42
15	125	107	94	83	75	68	63
30	250	214	188	167	150	136	125
60	500	429	375	333	300	273	250

4.5.5 Resetting the receiver

A POWERUP configuration (refer to your *Planning Reference Manual* for more information) is provided for default data collection. Holding the power button down for approximately 10-15 seconds will restore the default factory configuration (See Section 4.5.2.2, *Using the POWERUP configuration*, Page 47).

The receiver will beep twice to indicate that a reset has occurred. For more information see Section 4.2.2, *Audible annunciator*, on Page 33.

WARNING

Holding the power button for approximately 20 seconds will cause you to lose all data. For more information, see Section 4.2.1, *Power button*, on Page 31.

Appendix A

Radian IS Specifications

RADIAN IS SPECIFICATIONS	
Physical	
Size (diameter x height)	231 mm x 150 mm (0.76 ft x 0.49 ft)
Weight	1.75 kg (3.86 lb) - including two batteries 1.56 kg (3.44 lb) - without batteries
Description of Enclosure	The enclosure is constructed of molded plastic, closed with mounting screws and encircled by a rubber bumper. The Radian IS meets the IPX-7 specification enabling it to operate in wind driven rain and in a temporary submersion of up to approximately three-feet of water. A sealed access door on the side of the enclosure allows the insertion and removal of data cards and batteries.
Environmental	
Operating Temperature	With internal batteries: -20°C to +55°C (-4°F to 131°F) With external power: -40°C to +55°C (-40°F to 131°F)
Storage Temperature	With internal batteries: -30°C to +85°C (-22°F to 185°F) Without internal batteries: -40°C to +85°C (-40°F to 185°F)
Resistance Characteristics (when the Radian IS access door is closed)	Dustproof Waterproof (to the standards of RTCA/DO-160D Sec.10 Cat.R and IPX-7) Buoyant
Humidity	85% RH at +38°C (100.4°F), 95% RH at +65°C (149°F) (to the standards of RTCA/DO-160D Cat.C)
Altitude	Sea level to 5,000 m (16,404 ft) [may operate above 5,000 m in a controlled environment, however is not certified as such.]
Drop	2 m (6.56 ft) survival on hard surface, pole-mounted 1 m (3.28 ft) survival on hard surface, stand-alone

RADIAN IS SPECIFICATIONS**Vibration (Random Profile)**

The Radian IS can acquire and track satellites while undergoing vibration levels as shown below. It assumes that $C/N_0 > 45$ dB-Hz and that the Radian IS is in high-dynamics mode. Assuming appropriate mounting, the Radian IS conforms to random vibration templates for RTCA/DO-160D, Section 8 (Curve C template), MIL-STD-202F, Test Condition I (Letter A nominal template), and ASAE EP455, Section 5.15.1 nominal template.

Frequency	< 10 Hz, 10 Hz, 40 Hz, 1000 Hz, 2000 Hz, > 2000 Hz
Magnitude (g ² /Hz)	+ 80 dB/decade, 0.00125, 0.02, 0.02, 0.005, - 80 dB/decade

Power Requirements

Voltage	Internal: 7.2 V DC External: +9 to +18 V DC
Power	~4 W (typical while logging), 200 mW (off)

Peripheral Power Output

Voltage	≡ supplied voltage
Current	≤ 1A

Power Management

If the Radian IS is connected to two batteries, it begins using battery A. When battery A is discharged, the Radian IS switches to battery B (if available). Once battery reserves are depleted, the Radian IS becomes inactive. Normal operations are resumed when you connect an external power source to the system or when you install charged batteries.

Real-Time Clock

A real-time internal clock allows the Radian IS to turn off between scheduled data-collection sessions. When the Radian IS is on, this clock is synchronized to GPS time of ± 1 second.

Performance (Subject To GPS System Characteristics)

Frequency	1575.42 MHz (L1) & 1227.60 MHz (L2)
Codes tracked	C/A and P (or Y) codes
Channels	12 L1/L2 channel pairs
Time to First Fix	100 s (95% probability) 70 s typical (cold start: no initial time or almanac)
Re-acquisition	L1: 1 s typical L2: 10 s typical

RADIAN IS SPECIFICATIONS	
Performance continued...	
Computed Data Update Rate	10 solutions per second (maximum)
Measured Data Update Rate	10 data records per second (maximum)
Point Positioning	SA On: 40 m (131.2 ft) SA Off: 15 m (49.2 ft)
Accuracy ^a Carrier Phase Post-Processed	<p>Static Horizontal: 5mm + 1ppm * D Vertical: 10mm + 1ppm * D Occupation: 4SVs, 30sec rate, >1h</p> <p>Rapid-Static Horizontal: 5mm + 1ppm * D Vertical: 10mm + 1ppm * D Occupation: 5SVs, 15sec rate, >20min</p> <p>Stop-&-Go Horizontal: 10mm + 1ppm * D, D ≤ 10km 10mm + 2ppm * D, D > 10km Vertical: 20mm + 1ppm * D</p> <p>Kinematic - Horizontal: 10mm + 1ppm * D, D ≤ 10km 10mm + 2ppm * D, D > 10km Vertical: 20mm + 1ppm * D</p>
Accuracy ^b Carrier Phase RTK 1-sigma	<p>RTK Rapid Logs Horizontal: 3cm + 2ppm Vertical: 5cm + 2ppm Logging Rate: 10 Hz maximum</p> <p>RTK Matched Logs Horizontal: 1cm + 2ppm * D, D ≤ 10km Vertical: 2cm + 2ppm * D, D ≤ 10km Logging Rate: 4 Hz maximum</p>
RTK	Pseudorange & carrier-phase double differencing. Recommended conditions: <10 km baseline length; ≥ 6 satellites at an elevation > 12°; after 2 minutes convergence.
Time Accuracy (relative)	250 ns (SA on) does not include delays due to cable on RF section
Height Limit	Up to 18,288 m (60,000 feet), in accordance with export licensing
<p>a. Accuracy depends on number of satellites visible, obstructions, satellite geometry (DOP), occupation time, multipath effects, atmospheric conditions, baseline length, survey procedures, and data quality. 95% confidence level. Baseline not exceeding 10Km (except for Static survey type).</p> <p>b. With Base/Rover sharing at least 6 common satellites > 14 ° elevation, lock times > 3 min and GDOP < 4. Base station using integrated pinwheel technology antenna, and Rover station using integrated pinwheel technology antenna. Typical multipath, ionospheric, and tropospheric errors. Baseline not exceeding 10Km. For RTK rapid logs, not greater than 1 sec. correction latency.</p>	

RADIAN IS SPECIFICATIONS**Internal Batteries**

Model	Sokkia BDC46
Capacity	1300 mAh
Chemistry	Li-Ion
Operating Time 20°C	4.5 hours (using two batteries and no peripheral power output)
Charge Time	5 hours for two batteries (using Sokkia charger)

External Battery

Model	Sokkia model
Capacity	7200 mAh
Chemistry	Sealed lead acid (SLA)
Operating Time 20°C	18.5 hours (using no peripheral output)
Charge Time	5 hours (using Sokkia charger)

Input/Output Data Interface

Electrical format	EIA/TIA-232-E
EIA/TIA-232-E Baud Rate	4800, 9600, 19200, 57600, 115200 bps (9600 bps default)
Signals supported	TX, RX, RTS, CTS, DCD

Input/Output Strobes

PPS Output *	A one-pulse-per-second time synchronization output. This is a normally high, active low pulse (1 ms ± 50 ns) where the falling edge is the reference.
Mark Input *	An input mark (negative pulse > 55 ns), time tags output log data to the time of the falling edge of the mark input pulse.

The electrical specifications of the strobe signals are as follows:

Output	Voltage: Standard TTL levels Sink Current: 64 mA Source Current: 15 mA
Input	Voltage: Standard TTL levels Current: ≤ 5mA

* Additional cable required. Ask your dealer for a Command Descriptions Manual.

Glossary

Antenna - The antenna is the component of a GPS system that collects the analog signal from the GPS satellite and sends this signal to the GPS receiver for processing.

Baseline - The three-dimensional vector distance between a pair of stations for which simultaneous GPS data has been collected and processed with differential techniques. The most accurate GPS result.

Base Station - In differential positioning, a base station is the end of the baseline that is assumed known and its position fixed. The GPS receiver, which is acting as the stationary reference, is referred to as the base receiver, and it has a known position and transmits messages for the rover receiver to use to calculate its position.

Carrier Phase - The phase of either the L1 or L2 carrier of a GPS signal, measured by a receiver while locked-onto the signal (also known as integrated Doppler).

CMR - Compact Measurement Record, a standard communications protocol format used in Real-Time kinematic systems to transfer GPS carrier phase and code observations from a base station to one or more rover stations.

Coarse Acquisition (C/A) Code - The Course/Acquisition (or Clear/Acquisition) code modulated onto the GPS L1 signal.

Datum - See Geodetic datum

Differential GPS (DGPS) - a technique to improve GPS accuracy that uses pseudorange errors at a known location to improve the measurements made by other GPS receivers within the same general geographic area.

Dilution of Precision (DOP) - The geometry of the visible satellites is an important factor in achieving high quality results. The geometry changes with time due to the relative motion of the satellites. An accuracy measure for the geometry is the

Dilution of Precision (DOP) factor. For more information on DOP, refer to the Glossary section of the *Radian IS Advanced Reference Materials*.

Double-Difference Carrier Phase Ambiguity (or sometimes double difference ambiguity or ambiguity, for short) - carrier phase ambiguities which are differenced between receiver channels and between the base and rover receivers. They are estimated when a double difference mechanism is used for carrier phase positioning.

Elevation - Height above a reference datum. The reference datum may be an ellipsoid (ellipsoidal elevation), a geoid (orthometric elevation), above mean-sea-level, or above a locally defined reference plane.

Elevation mask angle - An adjustable feature of GPS receivers that specifies a satellite must be at least a specified number of degrees above the horizon before the signals from the satellite are to be used. Satellites at low elevation angles (five degrees or less) have lower signal strengths and are prone to loss of lock thus causing noisy solutions.

Ellipsoid - a smooth mathematical surface which represents the earth's shape and very closely approximates the geoid. It is used as a reference surface for geodetic surveys.

Ephemeris - a set of satellite orbit parameters that is used by a GPS receiver to calculate precise GPS satellite positions and velocities. The ephemeris is used in the determination of the navigation solution and is updated periodically by the satellite to maintain the accuracy of GPS receivers. Available as "broadcast ephemeris" or as post-processed "precise ephemeris."

Epoch - Same as measurement time epoch. The local time at which a GPS receiver takes a measurement. For Example, 15 seconds, 30 seconds.

Fixed solution - Processing of GPS vectors produces many solutions for the vector at different stages of the processing. One of the parameters being solved for during the processing is the integer ambiguities. A fixed solution is a vector solution where the integer ambiguities have been correctly determined and

fixed. The fixed solution for a vector is most often the best solution. If for some reason the ambiguities could not be solved, the final solution for the vector will be a float solution.

Float solution - Processing of GPS vectors produces many solutions for the vector at different stages of the processing. One of the parameters being solved for during the processing is the integer ambiguities. A float solution is a vector solution where the integer values for the ambiguities could not be determined, therefore they are not fixed to a specific integer value (left to float as a whole number).

Geodetic Coordinates - A coordinate system where the position of a point is defined using the elements latitude, longitude and geodetic height.

Geodetic Datum - A model of the earth used for Geodetic calculations

Geodetic Height (ellipsoidal height) - The height of a point above an ellipsoidal surface. The difference between a point's geodetic height and its orthometric height (height above ellipsoid) equals the geoidal separation.

Geoidal Separation (or Geoidal Height) - The height difference between the ellipsoidal height and orthometric height at a given point on the earth's surface. Worded differently, it is the separation between the geoid surface and the ellipsoid surface at a given point on the earth's surface.

Global Positioning System (GPS) - Full name NAVSTAR Global Positioning System, a space-based radio positioning system which provides suitably equipped users with accurate position, velocity and time data. For more information on GPS, refer to the Glossary section of the *Radian IS Advanced Reference Materials*.

GPS Time - The time system upon which GPS is based. GPS time is an atomic time system and is related to International Atomic Time in the following manner:

International Atomic Time (IAT) = GPS + 19.000 sec.

GPS Week - GPS time started at Saturday/Sunday midnight, January 6, 1980. The GPS week is the number of whole weeks since GPS time zero.

Greenwich Mean Time (GMT) - Time based on the Greenwich Meridian as reference. In distinction from time based on a local Meridian or the Meridian of a time zone.

International Atomic Time (IAT) - A time reference scale based on atomic clock readings from various laboratories around the world (established by the Bureau International des Poids et Mesures).

Interval (recording) - The time interval between the recording of GPS raw data to the GPS receiver memory. For example, a recording interval of 10 seconds indicates GPS raw data will be stored to the GPS receiver memory once every 10 seconds.

Ionosphere - The layers of ionized air in the atmosphere extending from 70 kilometers to 700 kilometers and higher. Depending on frequency, the ionosphere can either block radio signals completely or change the propagation speed. GPS signals penetrate the ionosphere but are delayed. This delay induces error in the GPS measurements that can result in poor survey results. Most GPS receivers/processing software model the ionosphere to minimize its affects. Also, the effects of ionosphere can be nearly eliminated by using dual frequency receivers which can calculate the delay due to ionosphere.

Ionospheric delay - A wave propagating through the ionosphere [which is a non-homogeneous (in space and time) and dispersive medium] experiences delay. Phase delay depends on electron content and affects carrier signals. Group delay depends on dispersion in the ionosphere as well and affects signal modulation (codes). The phase and group delay are of the same magnitude but opposite sign.

Kinematic - the user's GPS antenna is moving. In GPS, this term is typically used with precise carrier phase positioning, and the term dynamic is used with pseudorange positioning.

Kinematic surveying - A form of continuous differential carrier-phase surveying requiring only short periods of data observations. Operational constraints include starting from or determining a known baseline and tracking a minimum of four satellites. One receiver is statically located at a control point, while others are moved between points to be measured.

L1 - The 1575.42 MHz GPS carrier frequency, which contains the course acquisition (C/A) code, as well as encrypted P-code, and navigation, messages used by commercial GPS receivers.

L2 - A secondary GPS carrier, containing only encrypted P-code, used primarily to calculate signal delays caused by the ionosphere. The L2 frequency is 1227.60 MHz.

Mask Angle - see elevation mask angle.

Multipath - The reception of a satellite signal both along a direct path and along one or more reflected paths. The reflected signals are caused by reflecting surfaces near the GPS antenna. The resulting signal generates an incorrect pseudorange measurement. Multipath Errors are GPS positioning errors caused by the interaction of the GPS satellite signal and its reflections.

NMEA - National Marine Electronics Association, an organization that created industry standard ASCII log types that are used by all receivers.

Obstruction - Physical feature that blocks the satellite direct line of site from the point of observation. GPS signals are very weak. They can be blocked from reaching the GPS antenna by objects between the antenna and the satellites. Classic examples of obstructions are trees and buildings.

Occupation - The period of recorded data for a site. For example, a 1-hour period of data collection on a survey point is considered an occupation. Occupation is usually interchangeable with the term observation.

Orthometric elevation (orthometric height) - The height of a point above the geoid. Orthometric elevation is often equated with mean-sea-level elevation.

P-Code (precise or protected) - The protected or precise code used on both L1 and L2 GPS beacons. This code will be made available by the DOD only to authorized users. The P code is a very long (about 1014 bits) sequence of pseudo-random binary biphasic modulations on the GPS carrier at a chipping rate of 10.23 MHz which does not repeat itself for about 38 weeks. Each satellite uses a one-week segment of this code which is unique to each GPS satellite, and is reset each week.

Phase Center - The phase center of a GPS antenna is the physical location on the antenna where the raw GPS signals are observed. This is the physical location where the computed position will be determined. GPS antennas are manufactured to place the phase center as closely as possible to the physical center of the antenna housing. To determine the position of a survey marker on the ground, the GPS antenna (and thus the phase center) is centered over the marker and the height of instrument is measured to the survey marker for use during processing.

Precise Positioning Service (PPS) - the GPS positioning, velocity, and time service which will be available on a continuous, worldwide basis to users authorized by the U.S. Department of Defense (typically using P-Code).

Pseudorange - the calculated range from the GPS receiver to the satellite determined by taking the difference between the measured satellite transmit time and the receiver time of measurement, and multiplying by the speed of light. This measurement generally contains a large receiver clock offset error.

Pseudorange Measurements - measurements made using one of the pseudorandom codes on the GPS signals. They provide an unambiguous measure of the range to the satellite including the effect of the satellite and user clock biases.

Raw data - GPS data which has not been processed or differentially corrected.

RINEX - Receiver INdependent EXchange format. A set of standard definitions and formats to promote the free exchange of GPS data and facilitate the use of data from any GPS receiver with any software package. The format includes definitions for three fundamental GPS observables: time, phase and range. A complete description of the RINEX format is found in the Commission VIII International Coordination of Space Techniques for Geodesy and Geodynamics "GPSBULLETIN" May-June, 1989.

Rover - The GPS receiver that moves from site to site during a kinematics GPS survey. This receiver does not know its position and needs to receive measurements from a base station to calculate differential GPS positions.

RTCA - Radio Technical Commission for Aeronautics, an organization which developed and defined a message format for differential positioning.

RTCM - Radio Technical Commission for Maritime Services, an organization which developed and defined the SC-104 message format for differential positioning.

RTK - real-time kinematic, a type of differential positioning based on observations of carrier phase.

Site - A location or survey point where GPS data is collected.

Static Surveying - A method of GPS surveying that involves simultaneous observations between stationary receivers. Post-processing computes the vector between points.

SV - Space Vehicle or Satellites Visible

Undulation - The distance of the geoid above (positive) or below (negative) the mathematical reference ellipsoid (spheroid). Also known as geoidal separation, geoidal undulation, and geoidal height.

Universal Time Coordinated (UTC) - Time as maintained by the U.S. Naval Observatory. Because of variations in the Earth's rotation, UTC is sometimes adjusted by an integer second. The accumulation of these adjustments compared to GPS time, which runs continuously, has resulted in an 19 second offset between GPS time and UTC at the start of 2000. After accounting for leap seconds and using adjustments contained in the navigation message, GPS time can be related to UTC within 20 nanoseconds or better.

Index

A

- access door 17
- almanac 5
- antenna
 - features 16
 - pinwheel technology 26
- assistance, obtaining 6
- audible annunciator 33
- auto-generated file name 49

B

- base setup 12
- battery
 - features 20
 - indicator 39
 - power output 25
- button, power 31

C

- cable, insert/remove 23
- caution, usage 9
- clock drift 5
- closing access door 18
- collecting data 42
- collection fundamentals 42
- COM1 2, 10, 24
- COM2 2, 9, 25
- communications ports 24
- components, Radian IS 15
- consumption, power 30
- corrections, ionospheric 4
- current, maximum 9
- customer support 6

D

- data
 - collecting 42
 - defining 45
 - logging, interruption 29
 - post-processing 10
 - storage requirements 50
 - transferring 10
- data card
 - indicator 39
 - logging capacity 50
 - specifications 18
- data file naming 48
- display panel
 - features 16, 26–27
 - operations 31
- door
 - access 17
 - opening and closing 18
- drift, clock 5

E

- enclosure 15

F

- feature summary 4
- field setup 11
- file name convention 49
- file naming, data 48
- fundamentals, data collection 42
- fuse 9

G

gauges 34
general operations 39
getting started 10

I

icons 2
inactivity, system 28
indicator
 battery 39
 data card 39
 internal status 38
insufficient power 31
interruption, data logging 29
ionospheric corrections 4

L

logging capacity 50

M

magnetic variation 5
maximum current 9
measurements, pseudorange 4
mounting socket 16

N

name convention 49
naming, data file 48

O

office setup 10
operation
 display panel 31
 general 39
output, power and port 25
overview, enclosure 15

P

PCMCIA card 4
pinwheel technology antenna 25–26
ports 2, 22–23
power
 consumption 30
 input 24
 insufficient 31
 output 24–25
 source 29
 supply and control 28
power button 31
processing modes 3
pseudorange measurements 4
pulse aperture correlator 4

R

reset the receiver 50
rover setup 14
RS232 54

S

scheduled session 29
serial port 4
setup
 field 11
 office 10
signals, strobe 4
socket, mounting 16
static setup 11
status indicators, internal 38
storage requirements, data 50
strobe signals 4
subsidiaries 7
support, customer 6
system, turn on 28

T

technical assistance 6

U

undulation 5
usage cautions 9
using the Radian IS 28

V

variation, magnetic 5
voltage 9

W

where to find information 6

CE Declaration of Conformity

in accordance with EMC Directive 89/336/EEC of the European Community

We herewith declare that the undermentioned instrument, in view of its design and type of construction, fully complies with the relevant basic radio interference requirements of the EMC Directive.

Should the instrument be modified without agreement, this declaration becomes invalid.

Instrument Description : GPS receiver (Surveying Instrument)

Model Name : Radian IS

Relevant EC Directive : EMC Directive (89/336/EEC)
Version 92/31/EEC

Applied Harmonized Standards : EMI : EN5502/CISPR 22 Class B
EMS: EN50082-1

Firm : Sokkia BV

Address : Damluisweg 1,
Industrieterrein De Vaart,
1332 EA, Almere,
The Netherlands

Representative's Signature :



Date: 28 Nov 2000

Name of Representative : Hajimu Maeda

Representative's Position : European President

SOKKIA CO. LTD. INTERNATIONAL DEPT. 20-28, Asahicho 3-Chome, Machida, Tokyo, 194-0023 Japan, Phone +81-42-729-1848 FAX +81-42-729-1930

SOKKIA U.S.A. 16900 W 118th Terr, Olathe, Kansas, 66061 U.S.A., Phone +1-913-492-4900 Fax +1-913-492-0188

SOKKIA CANADA, 1050 Stacey Court, Mississauga, Ontario, L4W 2X8 Canada, Phone 1-905-238-5810 Fax 1-905-238-9383

SOKKIA CENTRAL & SOUTH AMERICA CORPORATION 1200 N.W. 78th Avenue, Suite 109, Miami, Florida, 33066 U.S.A., Phone +1-305-599-4701 Fax +1-305-599-470

SOKKIA PTY. LTD. Rydalmere Metro Centre, Unit 29, 38-46 South St., Rydalmere, NSW 2116 Australia, Phone +61-2-9638-0055 Fax +61-2-9638-3933

SOKKIA NEW ZEALAND 20 Constellation Drive, C.P.O. Box 4464, Mairangi Bay, Auckland 10 New Zealand, Phone +64-9-479-3064 Fax +64-9-479-3066

SOKKIA B.V. Businesspark De Vaart, Damsluisweg 1, 1332 EA Almere, P.O. Box 1292, 1300 BG Almere, The Netherlands, Phone +31-36-53.22.880 Fax +31-36-53.26.241

SOKKIA LTD. Datum House, Electra Way, Crewe Business Park, Crewe, Cheshire, CW1 6ZT United Kingdom, Phone +44-1270-25.05.25 Fax +44-1270-25.05.33

SOKKIA B.V. Niederlassung Deutschland An der Wachsfabrik 25, 50996 Köln (Rodenkirchen), Germany, Phone +49-2236-39.27.60 Fax +49-2236-6.26.75

BLINKEN A.S., Østskilen 4, Pb122, N-1620 Gressvik, Norway, Phone +47-69360910 Fax +47-69360920

SOKKIA S.R.O. Skroupovo náměstí 1255/9, 130 00 Praha 3, Czech Republic, Phone +420-2-6273715 Fax +420-2-6273895

SOKKIA S.A. Rue Copernic, 38760 Chasse-sur-Rhône, France, Phone +33-4-72.492.640 Fax +33-4-72.492.646

SOKKIA S.R.L. Via Alserio 22, 20159 Milano, Italy, Phone +39-02-66.803.803 Fax +39-02-66.803.804

SOKKIA N.V./S.A. Doornveld, Asse 3, Nr.11-B1, 1731 Zellik (Brussels) Belgium, Phone +32-2-466.82.30 Fax +32-2-466.83.00

SOKKIA KFT., Légszeszgyár u.17., 7622 Pécs, Hungary, Phone +36-72-226.636 Fax +36-72-324.636

SOKKIA KOREA CO., LTD. 2Fl. Chungam Bldg, 129-11, Chungdam-dong, Kangnam-ku, Seoul, Republic of Korea, Phone +82-2-514-0491 Fax +82-2-514-0495

SOKKIA SINGAPORE PTE. LTD. 401 Commonwealth Drive, #06-01 Haw Par Technocentre, Singapore 149598, Phone +65-479-3966 Fax +65-479-4966

SOKKIA (M) SDN. BHD. Dataran Prima, No.31-3, Jalan PJU 1/42A, 47301 Petaling Jaya, Selangor Darul Ehsan, Malaysia, Phone +60-3-7052197 / 7044240 Fax +60-3-7054069

SOKKIA HONG KONG CO., LTD. Rm.1416 Shatin Galleria,18-24 Shan Mei Street, Fo Tan, New Territories, Hong Kong, Phone +852-2-691-0280 Fax +852-2-693-0543

SOKKIA PAKISTAN (PVT.) LTD. Suite #A-2, 4th Floor, Westland Trade Centre, C-5, Central Commercial Area Blook 7 & 8, K.C.H.S.U. Ltd. Shaheed-e-Millat Road, Karachi, Pakistan, Phone +92-21-4313151 / 3 Fax +92-21-4313154

SOKKIA INDIA PVT. LTD. C-25, 2nd Floor, Sector-8, Noida-201301, India Phone +91-011-8-527850 / 525781 Fax +91-011-8-525769

SOKKIA GULF P.O.Box 4801, Dubai, U.A.E., Phone +971-4-368539 Fax +971-4-368549

SOKKIA RSA PTY. LTD. P.O. Box 7998, Centurion, 0046 Republic of South Africa, Phone +27-12-663-7999 Fax +27-12-663-7998

SOKKIA CO., LTD. SHANGHAI REP. Office 11F No.8, Tower 1 Kerry Everbright City, 218 Tian Mu Road West, Shanghai, #200070 Peoples Republic of China, Phone +86-21-63541844 Fax +86-21-63172083